

## 2,000L WATER CARTAGE TANK

**TOLERANCES**  
 NOTE: UNLESS NOTED OTHERWISE,  
 PLEASE ALLOW DIMENSIONAL TOLERANCES  
 DUE TO FABRICATION PROCESS AND  
 POLYETHYLENE THERMAL EXPANSION  
 DIMENSIONS <200mm - ALLOW ±3mm  
 DIMENSIONS 200 - 1000mm - ALLOW ± 5mm  
 DIMENSIONS >1000mm - ALLOW ± 10mm

MARK	PART	MATERIAL	PART CODE	DRAWING REF.
1	2,000L WATER CARTAGE TANK	BLUE WATER GRADE POLYETHYLENE	FFAR500.2021	
2	455mm HINGED LID - VENTED	BLACK POLYPROPYLENE	PARTAC.0203	

DRY WEIGHT: 110 KG APPROX.

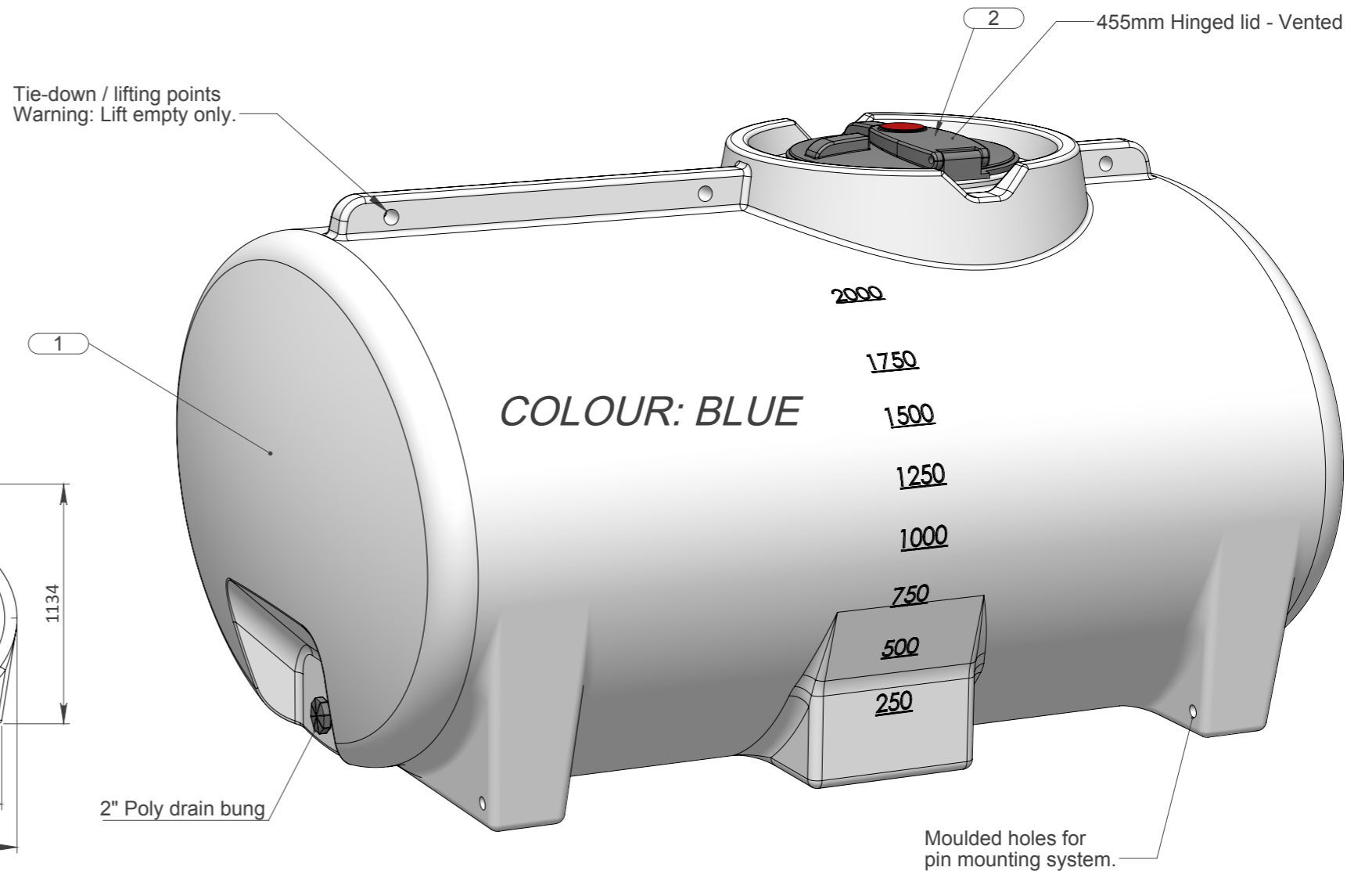
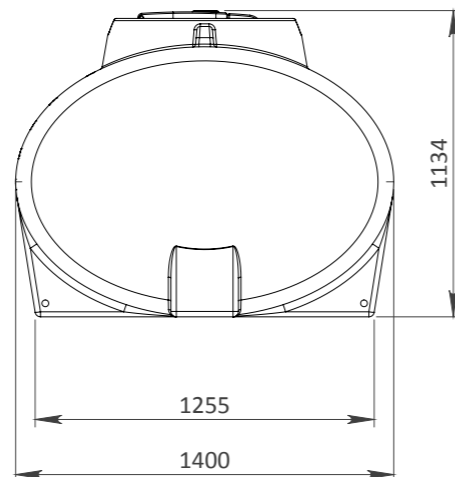
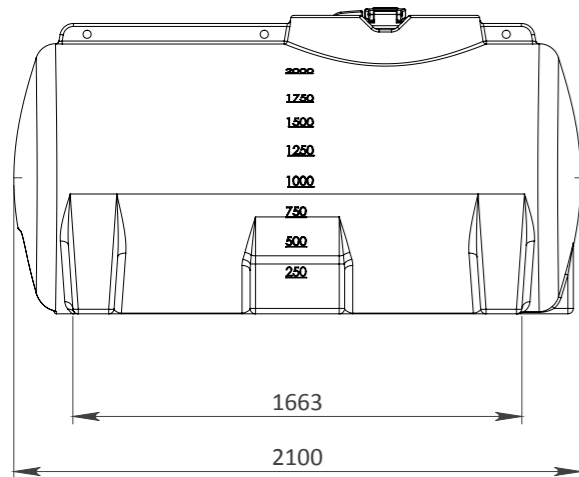
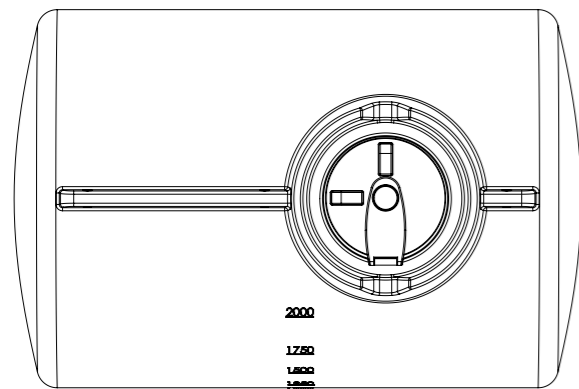

REV	DATE	REVISION DESCRIPTION	DRAWN	CHKD	LEAD ENG
A	17.10.18	AS BUILT	DH	JG	